

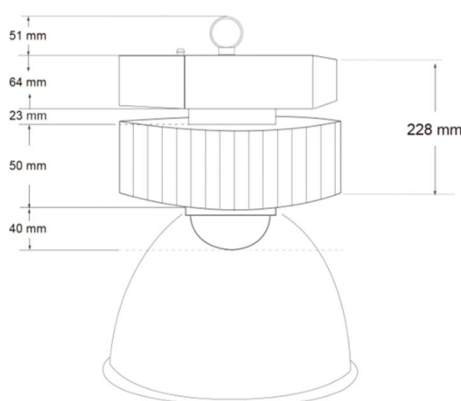

Mechanical drawing



Specification

Electrical

LED Power	135W
System Power	150W
Input Voltage	220-240V 90-305V
Power supply/Driver	Philips Xitanium Inventronics
Power factor	≥0.98
THD	<10%

Optical

LED Source	Lumileds LUXEON 5050
LED Efficiency	150-180lm/w
LED QTY	32pcs
Luminous Flux(lm)	21000
Beam Angle (Reflector)	Aluminum: 45°/90°/120° PC: 45°/90°
Color Temperature	3000K, 4000K, 5000K, 5700K
CRI	Ra70, Ra80, Ra90
Lumen Maintenance	L95B10@50,000hours
SDCM (MacAdam ellipse)	<5
Optical lens	Polycarbonate

Control & Dimming

Dimming	1-10v DALI
Switch off	Optional
Wireless	Zigbee
Daylight sensor	Optional
Motion sensor	Optional
Wireless sensor	Optional

General

Working Temperature	-40°C ~ 55°C
Frame color	Aluminum
Frame material	Aluminum 6063
Surface Treatment	Anodizing
Accessories	Hanging ring
Installation way	Ceiling
Life Span	100,000hrs
Warranty	5 years
Net Weight (kg)	4.3
Gross Weight(kg)	5.2
Packing size (cm)	34*34*29

Certificate & protection

IK Class	IK10
D-mark	Yes
IP-protection	IP20/IP65
Surge Protection	6kv/10kv
Certificate	CE SAA ENEC CB